

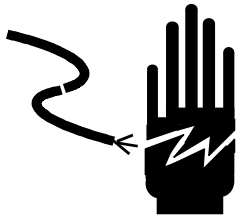





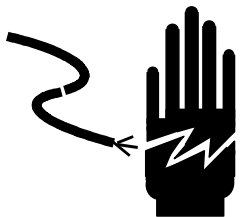

KM02A type weighing  
transducer  
User's Manual

# TPS

	 <b>WARNING</b>
	Ask specialist to debug, check and mend the transducer.

	 <b>WARNING</b>
	Please keep the weighing transducer earthing well.

 <b>CAUTION</b>
Weighing transducer is an electrostatic sensitive setting, so you should take actions to protect electrostatic when you use and maintain It.

Remain the right of amending this manual.



## Catalogue

1.0 General Description.....	1
1.1 Main Figure.....	1
1.2 Technical Standard.....	1
1.3 Load Capacity.....	1
1.4 Power Supply.....	1
1.5 Temperature & Humidity.....	1
2.0 Installing & debugging.....	1
2.1 Open Box for Checking.....	2
2.2 Cable junction of system.....	2
2.3 Cable connecting of load cells.....	2
2.4 Cable connecting of power and analog output.....	2
2.5 Debugging.....	2
2.6 Adjustment of current output (4~20mA).....	3
2.7 Adjustment of voltage output (0~5V or 0~10V).....	3
3.0 Note point in using.....	3

**MK SOLUTION (USA) CO.LTD**



Add : Plaza Vegas, 3305 Vest Spring Mountain Rd, #48,  
Las Vegas, Nevada 89102, USA



## 1.0 General description

This transducer is designed for industry controlling. It is readable, offers the way of standardization of load cells and controlling connector, also it is not easy to be affected by noise, so it is very popular. Various applied transducers, such as temperature transducer, force transducer, humidity transducer, weighing transducer and etc, offer the function as a bridge to transfer the various physical signal which depends on corresponding load cell into typical 4~20mA analog output.

KM02A type has no frozen, its using temperature is 0°C~85°C, humidity is 10%RH~95%RH.

## 2.0 Installing and debugging

This chapter will introduce how to install and debug indicator. Please read this chapter carefully before installing and using indicator.

### 2.1 Open box for checking

Open the package and check the parts as per packing list, which is together with the transducer. If there are missing or damaged parts, please contact forwarder and our company in time for getting quick and proper action from us.

### 2.2 Cable connecting of system

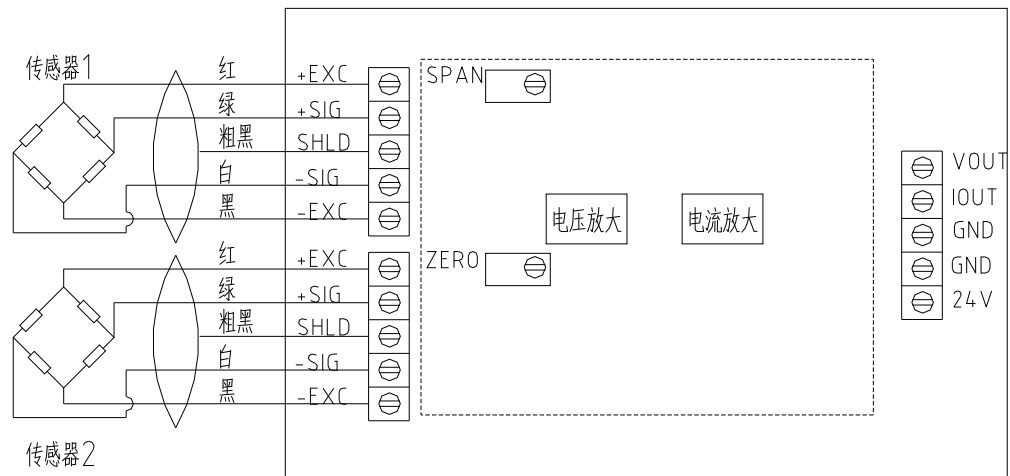



### 2.2.1 Cable connecting of load cells

Separately put cable-leads 1 and 2 into inside of weighing transducer through two ports that are at same side, and then connect as above drawing. If it is six cores load cell, you can first make excitation power and feedback cable be parallel connection then connect with (Red with blue, black and yellow). In application, if there is only one line that means you can only connect one load cell, then cable connecting is same as 1 and 2 cable-leads, but you should plug up the left port to protect the humidity and ash going into interior of the transducer.

### 2.2.2 Cable connecting of power supply and analog output

Please connect power supply and analog output as per bellow drawing

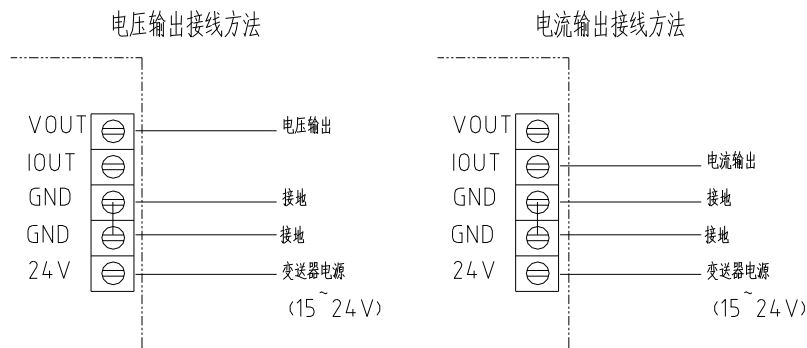

#### Notes:

- 1) you can only select one analog output: current output or voltage output.
- 2) The allowed power supply range of transducer is DC15V~24V, we recommend you to use 15V, 18V or 24V DC. When the environment temperature over 60°C, you should assure that the power supply will not be over 24V.

### 2.3 Debugging

**Please ask specialist to debug the weighing transducer. The wrong index may cause**



### **weighing transducer into mal-function.**

There are two precise POT in PCB, Zero adjustment POT with ' ZERO' mark, plus and minus adjustment POT is with ' SPAN' mark.

#### **2.3.1 Adjustment of current output (4~20mA)**

The lowest Zero output of this transducer can be around 2.7mA, full load output will be limited in about 32mA.

Step one: Connect and check as per 2.2.2

Step two: Using Current indicator to measure the output current when the loading setting under empty load situation. Adjust POT marked ' Zero' to make current output in 4.000mA. If you adjust POT in clockwise way, the current output will increase, if in anticlockwise way then the current output will decrease.

Step three: Increasing loading setting to full load or one loading point as n%F.S, then adjusting POT marked ' SPAN' to make current output in 20.000mA or  $4+n*16$ . If you adjust POT in clockwise way, the plus and minus will decrease, if in anticlockwise way then the plus and minus will increase.

Step four: Repeat step two, step three till the result is right.

#### **2.3.2 Adjustment of voltage output (0~5V or 0~10V)**

The lowest voltage Zero output of this transducer can be around - 0.3V, full load output will be limited in about 10.7V.

Step one: connect and check as per 2.2.2

Step two: Using voltage indicator to measure the voltage output when the loading setting under empty load situation. Adjust POT marked ' Zero' to make voltage output in 10.000V or  $10*n\%V$ ). If you adjust POT in clockwise way, the voltage output will increase, if in anticlockwise way then the voltage output will decrease.

Step three: Increasing loading setting to full load or one loading point as n%F.S, then adjusting POT marked ' SPAN' to make voltage output in 10.000V or  $10*n\%V$ . If you adjust POT in clockwise way, the plus and minus will decrease, if in anticlockwise way then the plus and minus will increase.

Step four: Repeat step two, step three till the result is right.

### **3.0 Note point in using**

3.1 After debugging. You should use frozen thing such as finger oil or wax to seal



the adjusting screw of POT in time, which is to protect from quivering or affect of POT caused by other reasons.

3.2 Please make the lid more sealed and tighten the plug of lining hole, which is for protecting from ash and water.